

Dresser Micro Series Volume Converter

Model MC2 – 197 PTZ

European Version



Model MC2-197 PTZ Converter Ex ia IIC T4 Ga (-40°C < Tamb < +60°C)
ATEX CERT No Baseefa17ATEX0086X Ex II 1 G
Caution! Static hazard, Clean only with a damp cloth, Do not use solvents
Natural Gas Solutions (UK) Ltd, Grimrod Place, Skelmersdale, Lancashire, UK, WN8 9UU
MID Approval No. T10332, Tamb -25 to +55 [°C], EVCD Model MC2

Table of Contents

1. Information	2
2. General Overview	2
2.1 Models Available	2
2.1.1 Protection of Legally Relevant Parameters	2
2.1.1.1 Hardware Link Protected	2
2.1.1.2 Software Password Protected	2
2.1.1.3 Firmware and EEPROM integrity	2
2.1.2 Accessories	2
3. Specification and Details	3
3.1 Pressure Measurement	3
Table 1 – Pressure Transducer Accuracy Reference Table	3
3.2 Temperature Measurement	3
3.3 Volume Input	3
3.4 Telemetry Output	3
3.5 Size	3
3.6 Serial Port	3
Figure 1 - MC2 Dimensions	4
3.7 Display	4
Table 2 – LCD Display for Method of Compression & Gas Specification	5
Table 3 – LCD and Alarm Conditions	5
3.8 Memory	5
3.9 Internal Supply	6
3.10 Environment	6
4. Safety	6
Table 4 – Capacitance and Inductance or Inductance to Resistance Table	6
Figure 2 – Intrinsic Safety System Diagram for Baseefa Compliance	7
5. Installation	8
5.1 Unpacking	8
5.2 Safety Requirements	8
5.3 EMC Compatibility	8
5.4 Mechanical Installation	8
5.4.1 Setting the Weights and Measures Link	8
Figure 3 – MC2 Mounting Hole Pattern	9
5.5 Electrical Installation	9
5.5.1 Location of the Connection Terminals	9
Figure 4 – Setting the Weights and Measure Link (Hardware Link)	10
5.5.1.1 Volume Input (TB1)	10
Figure 5 – Volume Input TB1 Connections	10
5.5.1.2 Temperature Measurement (TB2)	11
Figure 6 – Temperature Transducer Connections (TB2)	11
5.5.1.3 Telemetry Output (TB3)	11
Figure 7 – Telemetry Output Connections (TB3)	11
6. Maintenance	11
6.1 Replacing the Battery Pack	11
6.2 Pressure Sensor Calibration	12
6.3 Temperature Calibration	12
6.4 Restoring Factory Defaults	12

1. Information

All printed material contained within this handbook is for information only and is subject to change without notice.

2. General Overview

The Dresser Micro Series Volume Converter (MC2) combines 2 devices; an electronic counter and a volume converter. The MC2 is compatible with all Dresser Meters and meters from other manufacturers with a low frequency pulse output. Volume is sensed from low frequency pulses provided by a reed switch or Weigand pulser. The MC2 also has Data and Audit logging.

The MC2 is designed to measure live pressure and temperature to calculate Vb (Volume at base conditions).

The MC2 utilizes EEPROM memory which eliminates the need for back up batteries and hence all configuration data, and data and audit log entries will be stored during periods of no power. The data logging facility provides the operator with 3 independent operator configurable logging periods. The audit logging facility provides a means of tracking up to 32 changes to the configuration parameters. Both the data and audit logs are saved as CSV (comma-delimited) files to allow easy import into spreadsheets such as Microsoft Excel™. For further details regarding the data and audit logging facility consult the MC2 Software Manual.

The MC2 unit is designed (and approved intrinsically safe (I.S.)) for use in hazardous areas. A serial port allows communication with the unit. Configuration and interrogation is therefore possible, either directly via a laptop or remotely, via the Micro Modem. The unit can be used with this modem to initiate dial-out calls under alarm/fault conditions as required by the operator.

The MC2 is set up and calibrated using a computer and Dresser Natural Gas Solutions (NGS) "Micro Corrector User Terminal" (MCUT) software. This will allow:

- Set up**
- Calibration**
- Data extraction
- Alarm monitoring

** Disabled when the metrological seal is in place, it is only possible to activate by breaking the seal; this will negate the MID certification.

2.1 Models Available

The MC2 is factory built to suit customer order requirements. Options selectable include:

- Pressure measurement.
- External (with respect to the meter) absolute pressure measurement in the following ranges: 2, 12, and 70 bar.
- Platinum resistance thermometer (PT100) (temperature probe).

2.1.1 Protection of Legally Relevant Parameters

The parameters in measurement processing are secured against unauthorized modifications. The MC2 has two options for parameter protection that can be selected by the end user at time of order placement. The MC2 can be configured for either the password protection option or the hardware link protection option during the manufacturing process.

2.1.1.1 Hardware Link Protected

The MC2 has the capability to be configured with a hardware protection which allows a Read Only style of communication between the operator's computer and the corrector. In the "Read Only" position, no changes can be made to legally relevant parameters without physically breaking the seal. All legally relevant parameters are configured during the manufacturing process prior to the link being set in the read only position. If any change to these parameters is required, then the metrological seal must be broken.

If the hardware link is set to the "Read/Write" position, then changes can be made to legally relevant parameters and a record of any change is saved in the Audit Log. This Audit Log cannot be modified or deleted by the end user and is saved in non-volatile memory. Each parameter value change is automatically registered in the Audit Log and contains the following information:

- Parameter name
- Initial Value
- New Value
- Date/Time Stamp of the change

2.1.1.2 Software Password Protection

The MC2 also has the capability to be configured with a software seal where legally relevant parameters are protected by means of a password. Any person performing legally relevant parameter changes must know the password requested by the Micro Corrector User Terminal Software. Any change made to a legally relevant parameter is automatically registered in the Audit Log which cannot be modified or deleted by the end user. The Audit Log is saved in non-volatile memory and each parameter value change contains the following information.

- Parameter name
- Initial Value
- New Value
- Date/Time Stamp of the change

Refer to Paragraph 5.4.1 for further information.

2.1.1.3 Firmware and EEPROM integrity

A firmware CRC (Cyclic Redundancy Check) is performed every 10.5 minutes. The firmware version and CRC can be read on the display. If a CRC error is detected, "CrC" will be displayed as lower case "crc". In addition, an **Internal Fault** alarm will be raised and an "Int Flt" message displayed.

An EEPROM CRC is performed every 24 hrs and whenever communication with MCUT (Micro Corrector User Terminal) occurs. If an error is detected a **CRC Fault** alarm is raised and the "CHEcSunn" message is displayed.

2.1.2 Accessories

The MC2 Communication Pack consists of a serial cable terminated in a 7 pin screw locking DIN plug and 9 way "D" connector and application software CD. The pack is required for commissioning and configuring the MC2 before the Hardware link is set to Read Only position. Once the Read Only position is set, the MC2 communication pack can only be used to retrieve Data Logs and Audit Logs.

3. Specification and Details

Compliance to	Measurement Instruments Directive 2014/32/EU
EU Type approval certificate	T10332
Notified Body marking	CE 0122
Temperature rating	-25°C / + 55°C
Designed for	Condensing humidity
Environmental classes	M2 / E2

3.1 Pressure Measurement

The MC2 is fitted with 1 pressure transducer (where required). The pressure port is a 1/8" NPT male fitting. The various pressure transducers and associated percentage of accuracy are listed in Table 1 (Pressure Transducer Accuracy Reference Table).

Table 1 – Pressure Transducer Accuracy Reference Table

Pressure Transducer Range	Details
2 Bar A	MC2 maximum error of 0.4% of reading from 0.8 Bar A to 2.0 Bar A over operating temperature range of -40 °C to 60 °C
12 Bar A	MC2 maximum error of 0.4% of reading from 2 Bar A to 12 Bar A over operating temperature range of -40 °C to 60 °C
70 Bar A	MC2 maximum error of 0.4% of reading from 5 Bar A to 70 Bar A over operating temperature range of -40 °C to 60 °C

3.2 Temperature Measurement

Temperature measurement is performed by a 4-wire Class A 100 ohm platinum resistance thermometer (temperature probe) supplied as an option with the MC2. The wiring connections are made to a terminal block inside the MC2.

MC2 accuracy for temperature is better than 0.5°C over the gas temperature range -25°C to 60°C and operating temperature range -25°C to 55°C .

For connection details refer to section 5.5.1.2 (Temperature Measurement (TB2)).

Please note if you want to remove or change the temperature probe you will need to break the metrology seal.

3.3 Volume Input

The MC2 accepts low frequency pulses from positive displacement meters such as the Dresser Rotary meters. The meter must be fitted with a LF pulser such as the Dresser Solid State pulser or a dry LF Reed Switch. The value of the input pulses depends on the pulse value and its associated revolutions/m³ (rev/m³) value. For further details consult the MC2 Software manual.

For connection details refer to section 5.5.1.1 (Volume Input (TB1)).

3.4 Telemetry Output

There are 3 isolated Pulse outputs (V, V_b and fault), and 2 ground terminals. These ground terminals are isolated from the other ground terminals of the MC2. Each output is an open drain connection capable of sinking 10mA and up to 14.8 Volts (5 Volts max. above +40°C or +104°F). An external "pull up" resistor or current source is normally required to ensure that the circuit will function correctly. The value of the pulse outputs are operator configurable** from within the User Terminal, and may be set independently for V and V_b to 0.1 / 1 / 10 / 100 as required by the operator and as defined by meter type.

The Pulse outputs are connected to a terminal block (TB3) mounted internally and by default provide:

- Volume at measurement conditions (V) pulses.
- Volume at base conditions (V_b) pulses.
- Fault / Alarm indication.

The V and V_b outputs are isolated from each other (via GND1 (V) and GND2/3 (V_b)). The fault output shares the GND2/3 ground terminal with the V_b output.

The "ON" duration of the pulses at outputs 1 and 2 may be configured** to 62.5 ms, 125ms, 187ms or 315ms to suit the driven equipment. The Fault/Alarm indication (when configured) will pulse at approximately 1Hz when a fault condition is present.

The connection details for the telemetry output are shown in section 5.5.1.3 (Telemetry Output (TB3)).

**Disabled when the metrological seal is in place, it is only possible to activate by breaking the seal; this will negate the MID certification.

3.5 Size

Consideration should be taken to leave sufficient space below the convertor for running the cabling and pressure piping and to allow access to the serial communication port. Drawing showing the overall dimensions of the MC2 and location of the connections is shown in Figure 1 (MC2 Dimension Considerations).

For protection against static damage, it is essential that anti-static precautions are taken when the MC2 is opened for installation or maintenance.

3.6 Serial Port

The MC2 is fitted with an external 7 pin screw locking DIN connector for the serial port connections. Logic levels are 5 – 12V into the MC2 with a 5V nominal output from the MC2 (RS232 / RS232C levels).

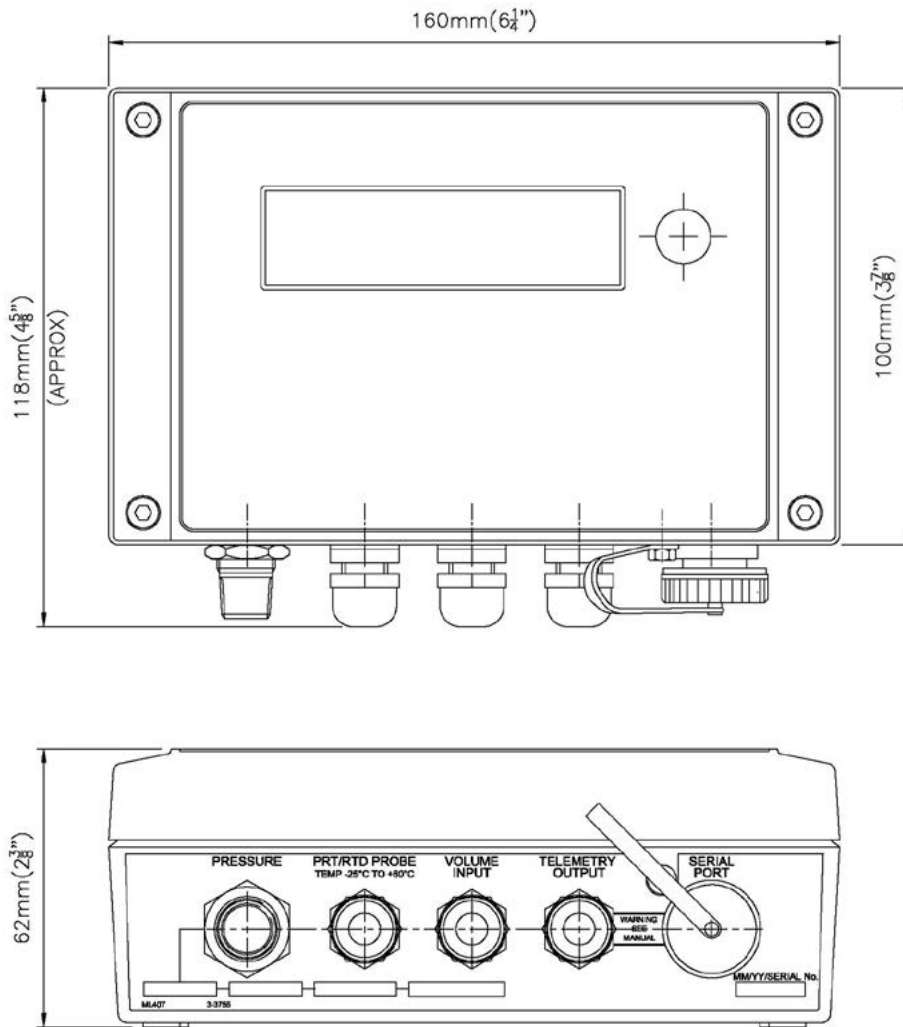

Figure 1 - (MC2 Dimension Considerations)

3.7 Display

The LCD display is permanently active and operational over the temperature range -25°C to 55°C.

The following parameters will always be displayed on the LCD and are **NOT** user configurable:

Main Screens

- Volume at Base Conditions (V_b) - this is always the default screen on the LCD
- Volume at Measurement Conditions (V)
- Flow Rate at Measurement Conditions (Q)
- Conversion Factor (C)
- Pulse Value
- Pressure (p)
- Temperature (T)

Additional Screens**

- Volume at Measurement Conditions under Fault (V under Fault)
- Base Temperature (T_b)
- Compressibility at Base Conditions (Z_b)
- Firmware Version / CRC (Alternating Display)
- Base Pressure (p_b)
- Pressure Factor
- Supercompressibility (Z_b/Z)
- Battery Voltage
- Compressibility at Measurement Conditions (Z) - Refer to Note 1
- Gas Composition & Method of Compressibility - Refer to Note 2

Configurable Screens**

Four additional parameters may be selected from the following options, which are located in the drop-down menus:

- Accumulated Volume at Base Conditions Previous Day
- Accumulated Volume at Base Conditions Current Day
- Accumulated Volume at Base Conditions Previous Month
- Accumulated Volume at Base Conditions Current Month
- Highest Daily Volume in the Previous Month
- Highest Daily Volume in the Current Month
- Date of Last Consumption Alarm
- Flow Rate at Measurement Conditions (Q_{max})
- Volume at Base Conditions (V_b) Residual
- Volume at Measurement Conditions (V) Residual
- Current Date
- Current Time

** NOTE: These are user definable, but requires the metrology seal to be broken.

NOTE 1: Z is displayed on the LCD only if compressibility is set at "Live Measurement" (not Fixed) on the converter configuration screen.

When Z is set at Fixed, the LCD display will show it as COnSt. When Z is set at Live Measurement, the LCD display will show the Gas Composition & Method of Compressibility.

NOTE 2: Select AUTO exit from gas composition screen or MANUAL exit from gas composition screen from the drop down menu in MCUT. The LCD display for method of compression and gas specification are as follows:

Table 2 - LCD Display for Method of Compression & Gas Specification

Method of Compression Calculation		Gas Specification	
Displayed	Represents	Displayed	Represents
1AGA8	AGA8 Gross Compressibility (GCM1) Method 1	XXXXXj	Heating Value (M/m ³)
2AGA8	AGA8 Gross Compressibility (GCM2) Method 2		
SG88 1	SGERG 88 Method 1	O.XXX G	Specific Gravity
SG88 2	SGERG 88 Method 2	XX XXX C	mol%CO ₂
SG88 3	SGERG 88 Method 3	XX XXX n	mol%N ₂
SG88 4	SGERG 88 Method 4	XX XXX H	mol%H ₂
n 19 n	NX19 Low Calorific Gases		
n 19 H	NX 19 High Calorific Gases		
COnSt	Fixed value of Supercompressibility Factor		

When shipped, the MC2 will display all parameters with the Volume at base conditions being default.

In alarm and / or fault conditions a message may be displayed on the LCD indicating the nature of the alarm and / or fault, see Table 3 (LCD and Alarm Conditions). For further information regarding the LCD consult the MC2 Software Manual.

Table 3 – LCD and Alarm Conditions

LCD Alarm Code	Alarm Condition	Additional Symbols Displayed
HP AL	High Pressure alarm	N/A
LP AL	Low Pressure alarm	N/A
Ht AL	High Temperature alarm	N/A
Lt AL	Low Temperature alarm	N/A
HF AL	High Flow alarm	N/A
LF AL	Low Flow alarm	N/A
D_In_AI / tAnnPER	Digital Input / Tamper Alarm	N/A
vol AL	High Consumption Alarm	N/A

LCD Fault Code	Fault Condition	Additional Symbols Displayed
Lo bAtt	Low Battery	Battery icon
P FLt	Pressure Fault	Alarm bell icon
T FLt	Temperature Fault	Alarm bell icon
Int FLt	Internal Operations Fault	Alarm bell icon
Pnn FLt	Pressure Monitor Fault	Alarm bell icon
CHEcSunn	CRC Fault	Alarm bell icon

3.8 Memory

The MC2 has non-volatile memory which means that in the case of battery failure, the MC2 will retain the configuration and all logged data and audit log information stored up until the time of power failure. This information will be available and ready for use when the battery is changed and power is restored.

Data logs are stored in non volatile memory. The total number of available logs is dependent upon the logging configuration chosen by the user - that is how many parameters are to be logged and in how many Logs. Up to 16 parameters can be logged in 3 separate logs.

The parameters that can be logged are as follows:

- Volume at Base Conditions (V_b)
- Volume at Measurement Conditions (V)
- Conversion Factor (C)
- Volume at Measurement Conditions under Fault (V under Fault)
- Average Flow Rate (Q) at Base Conditions
- Peak Flow Rate (Q) at Base Conditions
- Supercompressibility (Z_b/Z)
- Minimum Pressure (p_{min})
- Maximum Pressure (p_{max})
- Average Pressure (Average p)

- Ending Pressure (Ending p)
- Minimum Temperature (T_{min})
- Maximum Temperature (T_{max})
- Average Temperature (Average T)
- Ending Temperature (Ending T)
- Battery Voltage

For further information regarding Logging, please consult the MC2 Software Manual.

3.9 Internal Supply

The MC2 is powered by an internal alkaline battery pack giving a normal life of 5 years or a lithium battery pack with a nominal life of 15 years. The actual length of the battery life will depend on the conditions of use. The state of the battery is monitored and a low battery fault is set if remaining battery life is 10%. If the low battery indication is active, the battery pack should be replaced (see section 6.1 (Replacing the Battery Pack)).

Short term power is supplied by super capacitors to allow the unit to continue to function during battery replacement.

For safety reasons, the entire sealed battery pack must be replaced.

3.10 Environment

The MC2 may be operated over the following ranges:

Temperature	-40°C to 60°C.
Humidity	0 – 95% (condensing).
EMC	Directive 2014/30/EU
Ingress	IP66 and NEMA 4X for dust and water penetration, i.e. fully weatherproof.

4. Safety

Compliance to	ATEX Directive 2014/32/EU
ATEX EU Type approval certificate	Baseefa17ATEX0086X
ATEX Classification code	Ex II 1G Ex ia IIC T4 Ga -40°C ≤ Tamb ≤ 60°C
Temperature rating	-40°C ≤ Tamb ≤ 60°C
Notified Body marking	CE 1180

Input / Output Parameters

Telemetry

Uo = 7.4V Io = 130mA total Po = 180mW total Ci = 50nF Li = 1.5mH

Ui = 14.8V Ii = 130mA total Pi = 180mW total

Serial Port

Pins 1 - 6 w.r.t. pin 7

Uo = 7.4V Io = 60mA total Po = 170mW total Ci = 7.2nF Li = 0mH

Ii = 60mA total Pi = 180mW total

Pins 1 & 2 w.r.t. pin 7

Ui = +25V

Pins 3 - 6 w.r.t. pin 7

Ui = +7.4V

The connection of the MC2 to other instruments must be carried out in accordance with the Intrinsic Safety System Diagram shown in Figure 2 (Intrinsic Safety System Diagram for Baseefa Compliance). Use Figure 2 (Intrinsic Safety System Diagram for Baseefa Compliance) to achieve compliance with Baseefa requirements, as follows:

1. The installation must comply with the appropriate national installation conditions, e.g. in the UK BS 5345: Part 4:1977 or BS EN 60079-14.
2. The external circuits must be capable of withstanding an A.C. test voltage of 500V to earth or frame of the equipment, for a period of 1 minute, without breakdown.
3. Wiring for each external circuit may be achieved by separate cables or by separate circuits within a Type A or Type B multicore cable (as defined in clause 5.3 of EN50039).
4. The cables from the temperature probe and volume reed connections must not exceed 6m in length.
5. The capacitance and inductance or inductance to resistance (L/R) ratio of the cable connected to the telemetry output must not exceed the values shown in Table 4 (Capacitance and Inductance or Inductance to Resistance Table).
6. The serial port may only be connected to a computer when both the computer and MC2 can be regarded as being located in a non-hazardous area. The computer must be powered from a self contained battery and must not contain voltages in excess of 25V. The interconnecting cable must contain only 3 cores, connected to pins 1, 2 and 7 of the serial port connector. Pins 4 and 6 may be joined within the connector. Each conductor must have a minimum 0.25mm radial insulation.
7. The serial port may be connected to the I.S. GSM modem (Cert No. BAS99ATEX7049) at any time in accordance with Figure 2 (Intrinsic Safety System Diagram for Baseefa Compliance), and then the cable must comply with note 5.

Table 4 – Capacitance and Inductance or Inductance to Resistance Table

Group	Capacitance Co in μ F	Inductance Lo in mH or L/R ratio Lo/R in μ H/ohm	
IIC	0.102	0.4	78
IIB	0.84	2.7	363
IIA	2.97	5.3	775

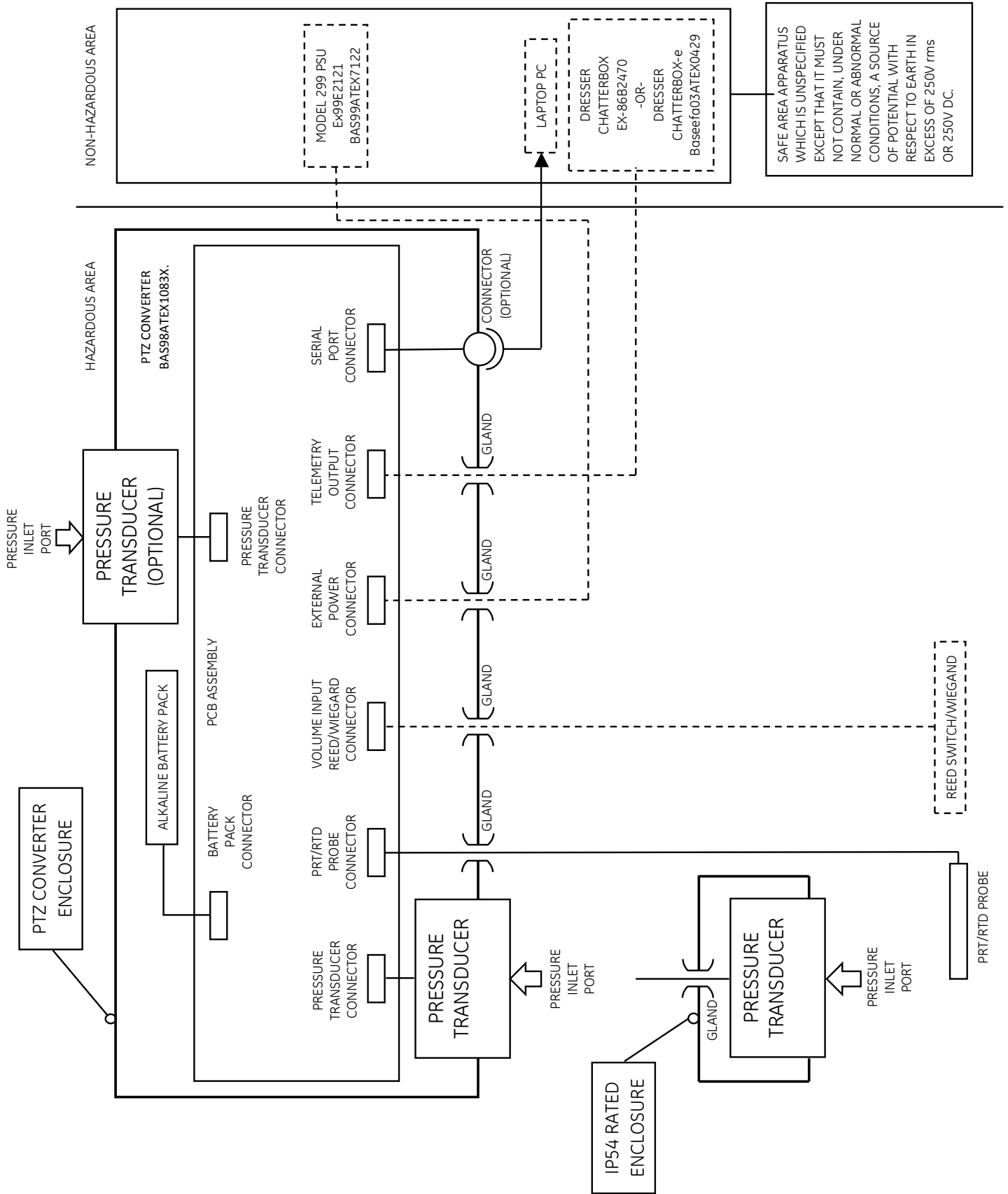

Figure 2 – Intrinsic Safety System Diagram for Baseefa Compliance

5. Installation

5.1 Unpacking

The following items are supplied with the MC2:

	Quantity
MC2 Manual	1
3mm hexagon wrench (Allen key)	1
Spacer	4
M6 x 20 panel mounting screw	4
Calibration certificate	1
MID Final Verification Test Report	1

The hardware and software (MCUT) manuals are auto-installed on the MCUT CD.

5.2 Safety Requirements

Where an MC2 installation must meet Intrinsic Safety requirements, refer to the Intrinsic Safety System Diagram (Figure 2) and section 4-Safety, before commencing installation. It is essential to follow any National Codes of Practice dealing with Intrinsically Safe installations. All Intrinsically Safe circuits must be segregated from non-I.S. circuits. The transducers used in the MC2 are intrinsically safe.

In line with the system drawings the MC2 must only be powered by an approved Dresser battery pack.

Connection of non intrinsically safe equipment not detailed in the System Drawing (Figure 2) into MC2 must be properly assessed by the user, and the manufacturer (Dresser) will not take responsibility for the overall safety of the system.

- Laptop computers, generally, are not intrinsically safe. Therefore, before using an uncertified laptop in the hazardous area, a gas test should be performed to prove that no potentially hazardous gas mixture exists in the area. If this is not possible the lap top must not be used in the hazardous area.
- The laptop computer must be powered by batteries alone and these must be incapable of supplying more than 25 Volts. No connection is to be made to an external supply (e.g. charger) even if non-operational. (The presence of the connection can itself create a hazardous condition).

The temperature probe is only suitable for use at atmospheric pressure and therefore must be used in conjunction with a thermowell which is capable of withstanding the line pressure.

All individual wires connected to the circuit board must have at least 0.25mm (1/100 ins) of insulation.

5.3 EMC Compatibility

To ensure that the performance specifications are not significantly affected by electromagnetic interference, it is essential that:

- All conductors are adequately shielded using braided screens and that these screens are terminated as recommended in this manual.
- Except where stated otherwise, the length of external

connections should not exceed 3m (9.57ft).

- If equipment which is not approved by the manufacturer (Dresser Natural Gas Solutions) is connected to the MC2, it is the operator's responsibility to ensure that this equipment is installed and operated in a manner which will ensure that the system is compliant with the relevant EMC standards.
- For protections against static damage, it is essential that anti-static precautions are taken when the MC2 is opened for installation or maintenance.

5.4 Mechanical Installation

The MC2 is designed to mount to a vertical surface. The MC2 mounting holes are tapped M6 and the unit may be mounted on a 1.6mm (1/16 in) panel.

5.4.1 Setting the Weights and Measures Link

If operator configuration is required to set up the unit, the Weights & Measures Link will need to be switched to the Read/Write position. To set the Read/Write link:

1. If the MC2 is in a hazardous area the setting of the Weights and Measures Link should NOT be carried out as the PCB protection plate is removed. The set up procedure should be carried out prior to installation. Please note changing the Weights and Measures Link position requires the metrology seal to be broken.
2. Remove the 4 screws securing the MC2 cover using the 3mm hexagon wrench (Allen key) supplied. If the 3mm hexagon wrench is not available a 7/64 ins wrench will work.
3. Lift the front panel forward to expose the PCB protection plate that covers the main circuit board.
4. Remove the 2 PCB protection plate retaining screws (breaking metrological seal which needs to be replaced).
5. Identify the Read/Write protection link; remove from the Read Only position and replace in the Read/Write position. Refer to Figure 3 (Setting the Weights and Measures Link).
6. The necessary parameter changes should now be carried out via the User Terminal (for further information consult the MC2 Software Manual).
7. Once the necessary parameter changes have been uploaded to the unit the Read/Write position should be replaced to the Read Only position.
8. Replace the 2 PCB protection plate retaining screws. Any required seal must be replaced by the appropriate authority before re-closing the unit.
9. The MC2 cover should be installed checking that no wiring is trapped between the cover and body.
10. Install the 4 front cover fixing screws and tighten these a little by hand until all screws are started.
11. Carefully hold the cover against the body to form the seal and tighten the 4 securing screws using a 3mm hexagon wrench (Allen key). Ensure that cables are retained in the enclosure and not trapped in the lid seal.

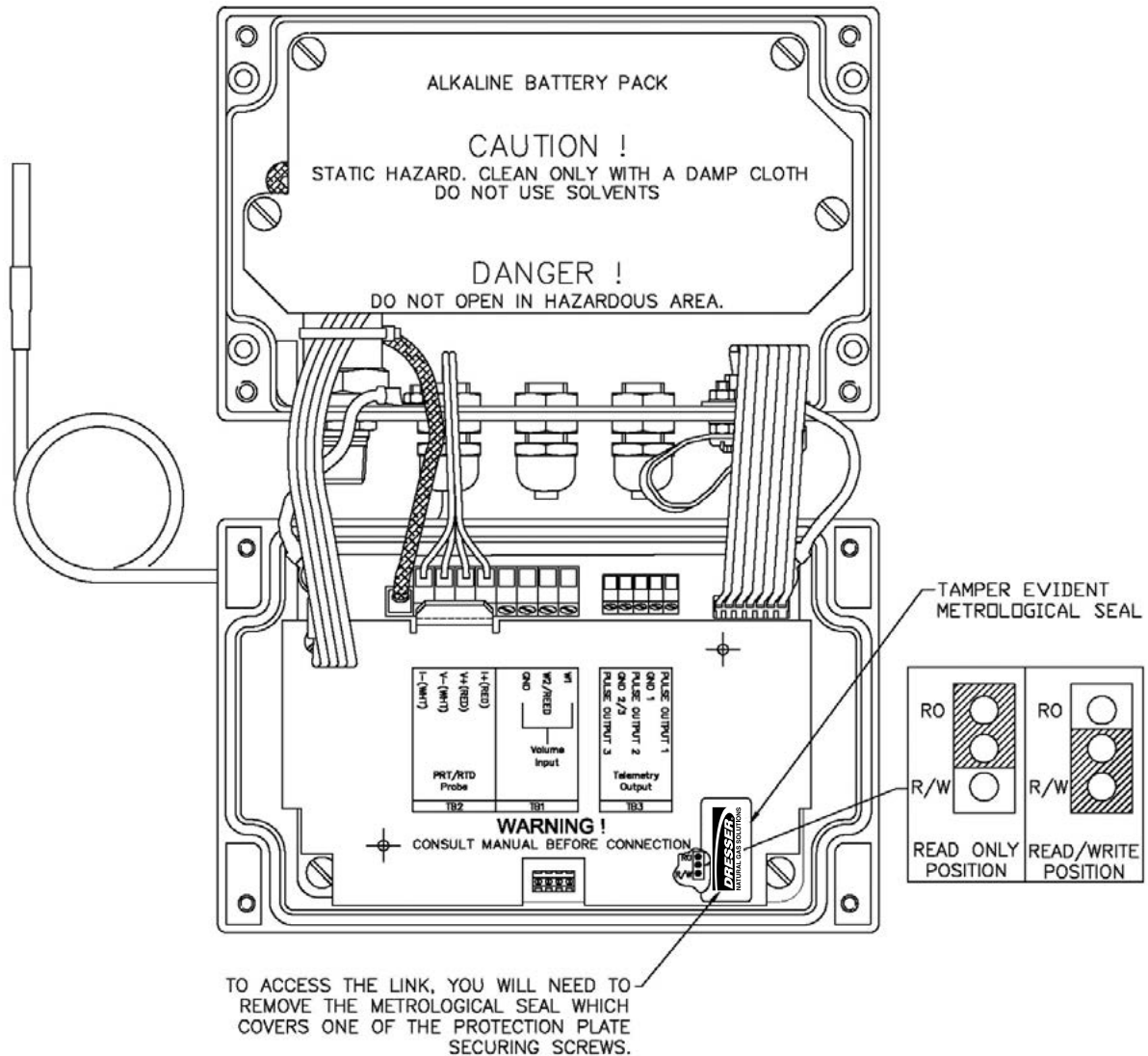

Figure 3 – Setting the Weights and Measure Link (Hardware Link).

5.5 Electrical Installation

Electrical installation should be performed by a person competent and knowledgeable about installation of intrinsically safe equipment and totally conversant with the National Code of Practice.

For protection against static damage it is essential that anti-static precautions are taken when the MC2 is opened for installation or maintenance.

5.5.1 Location of the Connection Terminals

When the MC2 case is opened, the location of the connections terminals will appear as in Figure 4 (Location of the Connection Terminals):

1. Remove the 4 screws securing the MC2 cover using the 3mm hexagon wrench (Allen key) supplied. If the 3mm hexagon wrench is not available a 7/64 ins wrench will work.
2. Open the cover to expose the PCB protection plate.

3. Carry out the electrical installation as required (refer to sections 5.5.1.1 (Volume Input (TB1)), 5.5.1.2 (Temperature Measurement (TB2)) and 5.5.1.3 (Telemetry Output (TB3))), and once complete the MC2 front panel should be replaced and secured. Please note if you want to install the temperature probe you will need to break the metrology seal.
4. The MC2 front panel should be offered up to the case checking that no wiring is trapped between the panel and body.
5. Re-introduce the 4 front panel fixing screws and tighten these a little by hand until all screws are started.

Note: If the case is to be wired and sealed by the Weights and Measures authority, the 4 spacers supplied should be fitted under each head of the front panel securing screws so that the wiring holes are accessible when the screws are fully tightened.

6. Carefully hold the front panel against the body to form the seal and tighten the 4 securing screws using a 3mm hexagon wrench (Allen key). Ensure that the cables are retained within the enclosure and are not trapped in the front panel seal.

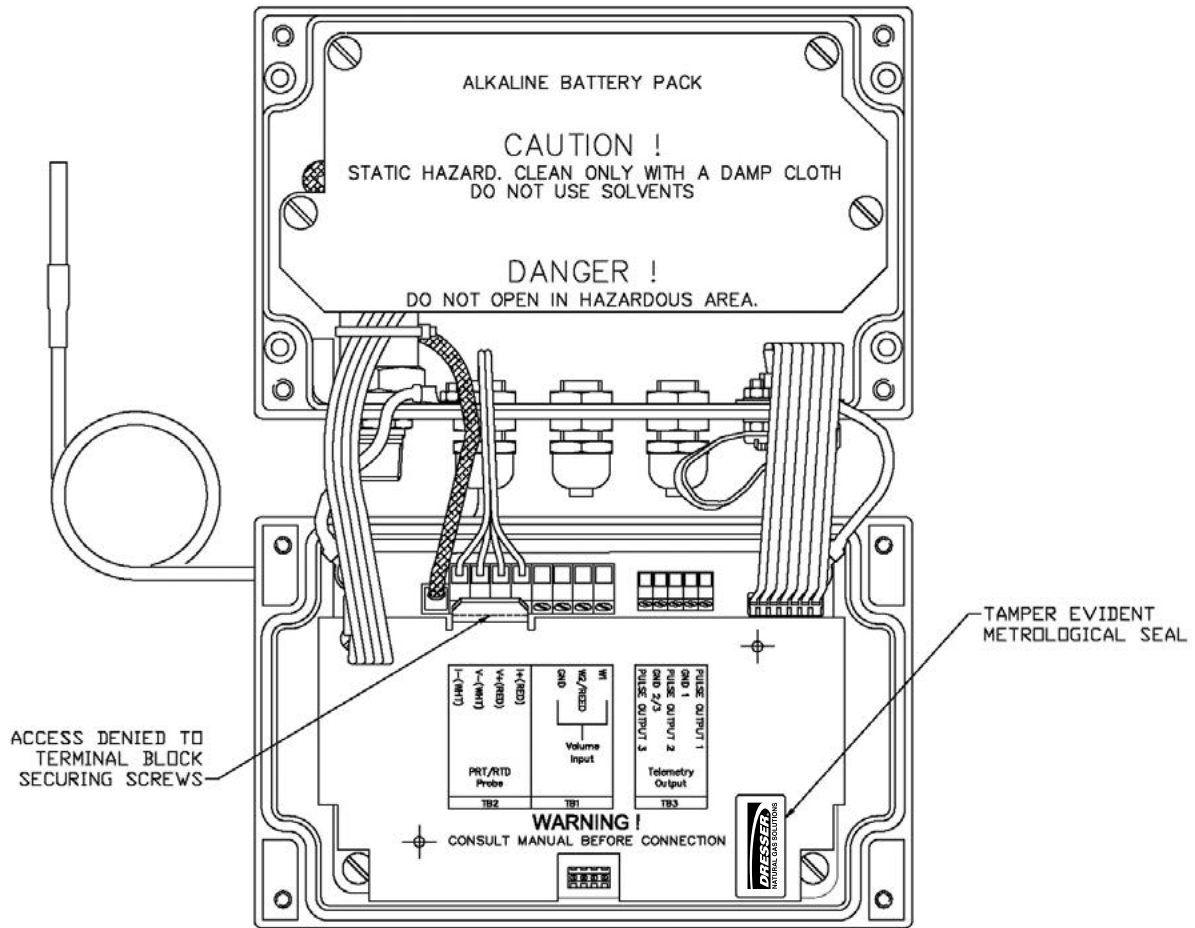

Figure 4 - Location of the Connection Terminals

5.5.1.1 Volume Input (TB1)

The source of the volume input should be connected to the GND and W2/REED Volume Input terminals of TB1, as shown in Figure 5 (Volume Input (TB1) Connections).

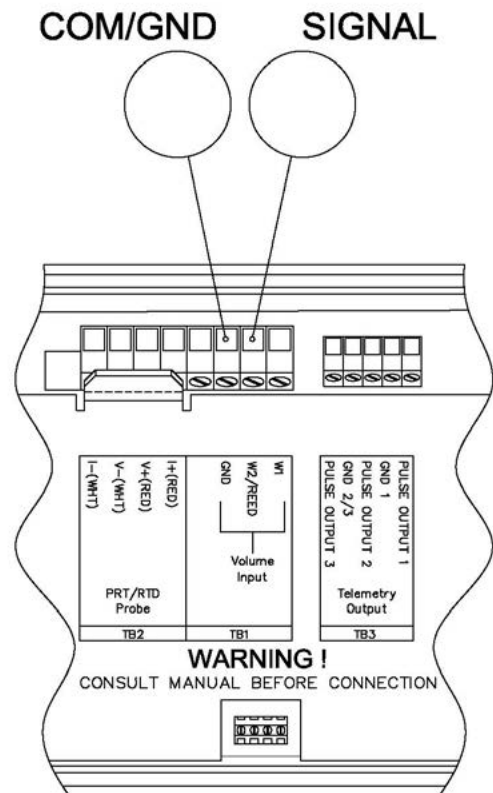

Figure 5 - Volume Input TB1 Connections

5.5.1.2 Temperature Measurement (TB2)

The temperature measurement is accomplished via a temperature probe.

The wires should be connected to the PRT/RTD Probe terminals of TB2, as shown in Figure 6 (Temperature sensor Connections).

Please note if you want to install the temperature probe you will need to break the metrology seal.

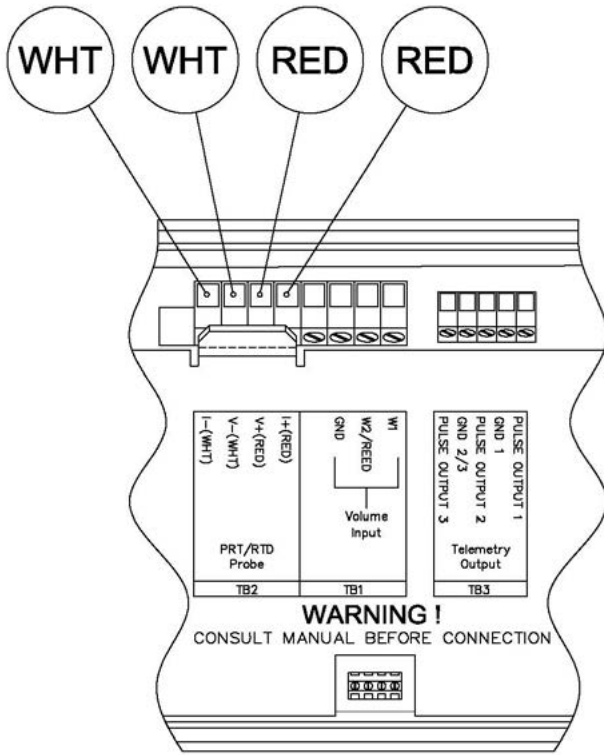

Figure 6 – Temperature Sensor Connections (TB2)

6. Maintenance

There is no requirement for routine maintenance of the MC2. A pressure check may be performed by applying a known test pressure to the pressure transducer and reading the pressure value from the front panel display of the MC2. The error as a percentage of reading should be calculated as follows:

$$100 \times ((p_{ind} - p_{true}) / p_{true})$$

Where p_{ind} is the indicated pressure reading on the display and p_{true} is the known measured pressure. For further details refer to section 6.2 (Pressure Transducer Calibration).

The temperature calibration** may also be performed by immersing the temperature probe into a container of liquid of a known temperature. For further details refer to section 6.3 (Temperature Calibration).

6.1 Replacing the Battery Pack

“Lo bAtt” indication appears on LCD if remaining battery life is 10%. Battery fault is set and recorded in Audit Log with Date/Time stamp.

If the low battery indication is active, the battery pack should be replaced.

5.5.1.3 Telemetry Output (TB3)

Figure 7 (Telemetry Output Connection (TB3)) shows the connections for the telemetry output. Other Dresser NGS approved products, such as the Dresser Chatterbox (isolation unit) may be connected to the telemetry outputs. Any equipment connected to the telemetry output must be individually assessed to ensure that the system is safe. Connection to intrinsically safe equipment not detailed in the system drawing (see Figure 2 (Intrinsic Safety System Diagram for Baseefa Compliance)) must be properly assessed by the user, and the manufacturer (Dresser NGS) will not take responsibility for the overall safety of the system.

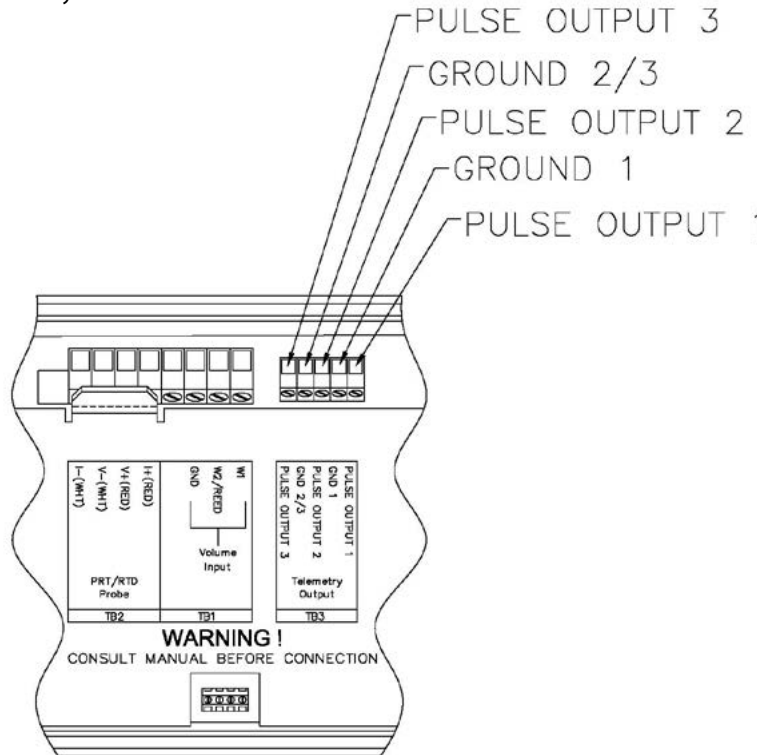

Figure 7 – Telemetry Output Connections (TB3)

MC2s should not be left with discharged packs inside them as discharged cells are more prone to leak than are new or partially used cells. If the MC2 is to be stored for any length of time, the battery pack should be removed and stored separately.

Before replacing the battery pack press the front panel selector button on the MC2. This operation ensures that the latest V_b and V totals are stored in the permanent memory of the MC2. Super capacitors will maintain normal operation of the converter during battery replacement.

For protection against static damage, it is essential that anti-static precautions are taken when the MC2 is opened.

The battery pack affects the intrinsic safety of the MC2 and must be replaced with the correct Dresser battery pack. To replace the battery pack:

1. Press the front panel selector button on the front of the MC2.
2. Unscrew the 4 screws retaining the front panel of the MC2 using a hexagon wrench or suitable Allen key (as described in section 5.5 Electrical Installation).
3. Unplug the battery connector from the main circuit board mounted behind the front panel.

4. Use a screw driver to remove the 4 screws (and 4 washers) holding the battery pack.
5. Remove the old battery pack.
6. Place the new battery pack in to position and replace the 4 screws and 4 washers.
7. Plug the new battery pack into the main circuit board, such that the battery plug engages correctly with the connector locking ramp on the circuit board.
8. Check that the MC2 displays the default parameter of the LCD and the normal operation has resumed.
9. Carefully dress the battery lead and the other wirings so that they will not be trapped between the enclosure and front panel.
10. Replace and retighten the screws holding the front panel as described in section 5.4 Mechanical Installation.

NOTE 1: Observe any local regulations on disposal of battery packs.

NOTE 2: If changing from an alkaline battery pack to a lithium battery pack, the MC2 battery type has to be changed from Alkaline to Lithium using the MCUT software.

Next, press the front panel scroll button and hold for 30 seconds minimum until the message "bAtt 180" appears on the LCD.

6.2 Pressure Transducer Calibration

Calibration of the pressure transducer should not be required however, the MC2 may be pressure calibrated** by the operator, using the serial port of the MC2 and the User Terminal software. It is possible to calibrate either the zero only or both the zero and the span.

For further details regarding the pressure calibration refer to the MC2 Software Manual.

** Disabled when the metrological seal is in place, it is only possible to activate by breaking the seal; this will negate the MID certification.

6.3 Temperature Calibration

Temperature calibration should not be required however, the MC2 may be temperature calibrated** by the operator, using the serial port of the MC2 and the User Terminal software.

To obtain temperature calibration points use one of the following methods:

Use temperature controlled baths with the MC2 temperature probe and a calibrated thermometer for determining the bath temperatures. As an alternative use a vacuum flask filled with liquid which is well stirred, and place the temperature probe and calibrated thermometer in this.

OR

Simulate the temperature probe using a calibrated decade resistance box set to values corresponding to 2 different temperatures. If this option is chosen the temperature probe must be disconnected from the MC2 and the resistance box must be connected as a 4 wire resistor in its place.

If stability is not obtained the calibration process will not be successful.

For further details regarding the temperature calibration refer to the MC2 Software Manual

** Disabled when the metrological seal is in place, it is only possible to activate by breaking the seal; this will negate the MID certification.

6.4 Restoring Factory Defaults

It is possible to restore the factory defaults for pressure and temperature** from within the User Terminal. For further details consult the MC2 Software Manual.

** Disabled when the metrological seal is in place, it is only possible to activate by breaking the seal; this will negate the MID certification

Dresser Meters & Instruments
Natural Gas Solutions (UK) Limited
22 Grimrod Place
Skelmersdale UK, WN8 9UU
T: +44 (0) 1695 52604

© 2018 Natural Gas Solutions North America, LLC – All rights reserved. Natural Gas Solutions reserves the right to make changes in specifications and features shown herein, or discontinue the product described at any time without notice or obligation. Contact your Dresser Natural Gas Solutions representative for the most current information. The Dresser Logo and all Trademarks containing the term "Dresser" are the property of Dresser, LLC, a subsidiary of Baker Hughes, a GE Company.



www.dresserngs.com